

Packaging item:

VUL/SK 24/12 REL

Date:

1-7-2011

Internal code:

N/A

General product specification		
Description	VUL/SK 24/12 REL	
	Closure fitting for total drainage metal containers with 24mm REL-piercing.	
	Two piece, PE made. Base with tamper evidence tear-off seal and	
	universal insertion edge. Screw cap, ergonomical shaped, 12 mm high,	
	with bore seal.	
Product properties		
Components	Resin LDPE	
	Resin HDPE General	
Storage		
Storage temperature	Minimum	10°C
	Maximum	28°C
	Pallets should be stored in a clean dry area from UV light, smels and high temperature variations. Pallet should not be double stacked.	
Application		
Application temperature	Minimum	18°C
	Maximum	28°C
	Max. head pressure	250 N
	Meeting the above requirements does not absolve the customer from the requirement to set up the capping equipment as required and from carrying out compatibility tests between the applied closure and filled product.	
	Technical assistance can be provided by Mus Verpakkingen BV.	
Packaging		
Weight (gr)	5,58 gr ± 10%	
Packaging	Carton 3.500	pcs./carton
	Cartons/pallet	20
Remarks		
Tolerances	Customer drawing tolerances relate to the results of measurement averages, except for ovality. Ovality tolerances depend upon transport conditions, packaging media, vibration and temperature.	

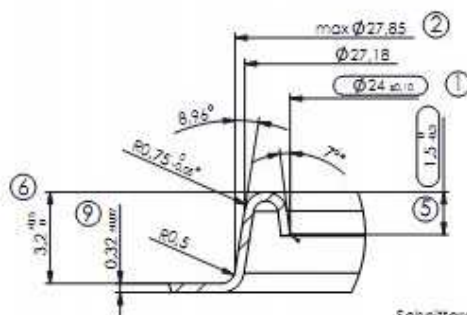
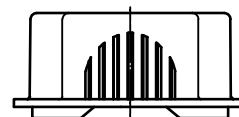
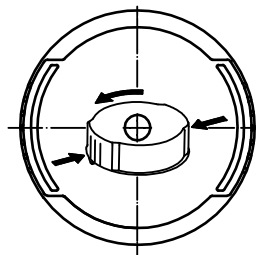
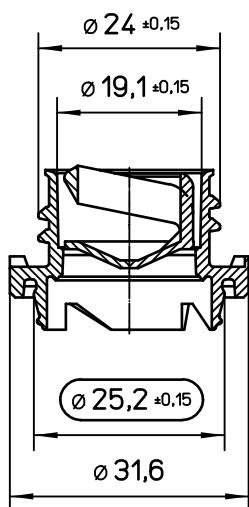
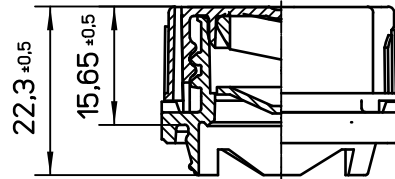
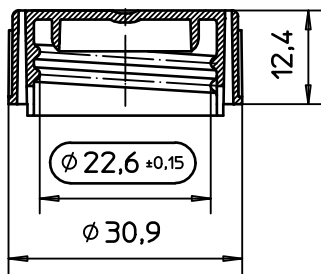

Schnittgrat/Burr
Form 2 /shape 2
(stapelfähig/nestable)

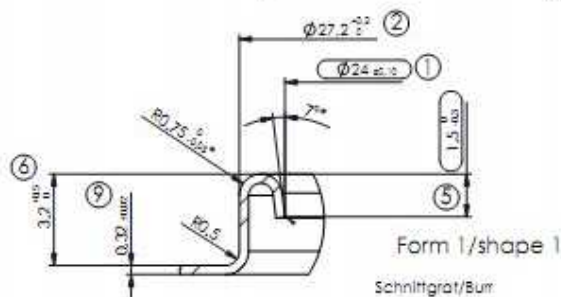

Form 1 /shape 1
Schnittgrat/Burr